

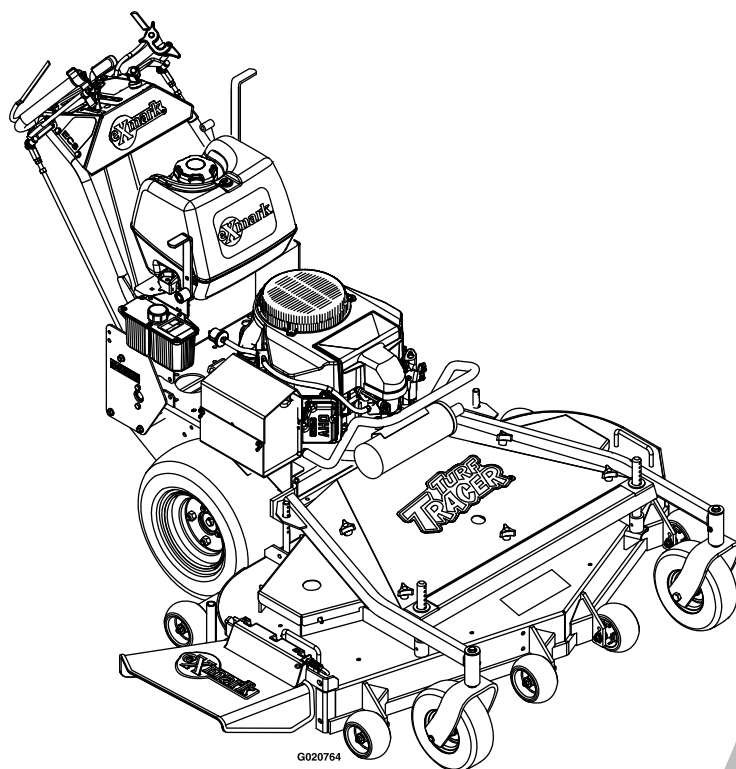

TURF TRACER® S-SERIES

Model No. TTS481KA363—Serial No. 31400000 and Up

Picture below may not reflect actual product.



Parts Manual

Part No. 4501-820 Rev. A

Ordering Replacement Parts

To order replacement parts, please supply the part number, the quantity, and the description of each part desired.

Understanding Reference Numbers

Each identified part in an illustration has a reference number. The reference number for a part also appears in the parts list, along with other information about the part.

This catalog uses two special reference number formats, one to indicate parts in a service assembly and another to indicate the quantity of a given part in an illustration.

Service Assembly Reference Numbers

Parts in service assemblies have reference numbers in the form a:b. The a represents the reference number of the entire service assembly and the b represents a sequential number unique to each part within the service assembly.

For example, a wheel assembly might be identified by reference number 6, the tire by 6:1, the valve by 6:2, and the wheel by 6:3. When you order the assembly identified by reference number 6, you receive all parts identified by reference numbers 6:1, 6:2, and 6:3. However, you may also order any part individually. Reference numbers of this type appear in illustration and in parts lists.

Reference Numbers Indicating Quantity

In an illustration, if a reference number indicates more than one part, the reference number has the form nX y. The n represents the quantity of the part, the X is the multiplication symbol, and the y represents the reference number.

For example, in an illustration, the reference number 2X 37 means that two of the parts identified by reference number 37 are indicated.

List of Abbreviations

AR: as required	HJ: hex jam	PRH: phillips round head
ASM: assembly	HLH: hex lag head	PTH: phillips truss head
BBC: blade brake control	HOC: height-of-cut	PTO: power-take-off
BHTF: button head thread forming	HSBH: hex socket button head	RH: right hand
CARR: carriage	HSFH: hex socket flat head	ROPS: roll-over protection system
CCW: counter clockwise	HSH: hex socket head	RRB: rear roller brush
CW: clockwise	HWH: hex washer head	SFH: slotted fillister head
DEG: degrees	HWHTF: hex washer head thread forming	SHH: slotted hex head
DPA: Dual Point Adjustment	HYD: hydraulic	SHWH: slotted hex washer head
ECM: electronic control module	LH: left hand	SPH: slotted pan head
EXT: external	LP: Liquefied Petroleum Gas	SQH: square head
FH: flat head	LPG: Liquefied Petroleum Gas	SRH: slotted round head
GA: gauge	NI: nylon insert	STD: standard
HD: heavy-duty	NPTF: national pipe thread fine	TAP: self tapping
HF: hex flange	PFH: phillips flat head	TTH: torx truss head
HH: hex head	PPH: phillips pan head	
HHF: hex head flange	PPHTF: phillips pan head thread forming	
HHFTF: hex head flange thread forming		

Touch Up Paint

Exmark black touch up spray paint – gloss black.

Exmark red touch up paint (spray paint – P/N 1-850337 - .6 oz liquid bottle – P/N 103-9140).



If your Exmark dealer does not have the Exmark part in stock, Exmark will get the parts to the dealer the next business day or the part will be FREE Guaranteed!! (Some restrictions apply. See your participating Exmark Dealer for details.)

Contents

Mower Deck Assembly	4
Engine Deck Assembly	6
Engine Deck Assembly (cont)	8
ECS Upper Handles and Controls Assembly	10
Fuel Tank Assembly	12
Electrical Assembly	13
Decals	14
Hydraulic Assembly	16

Mower Deck Assembly

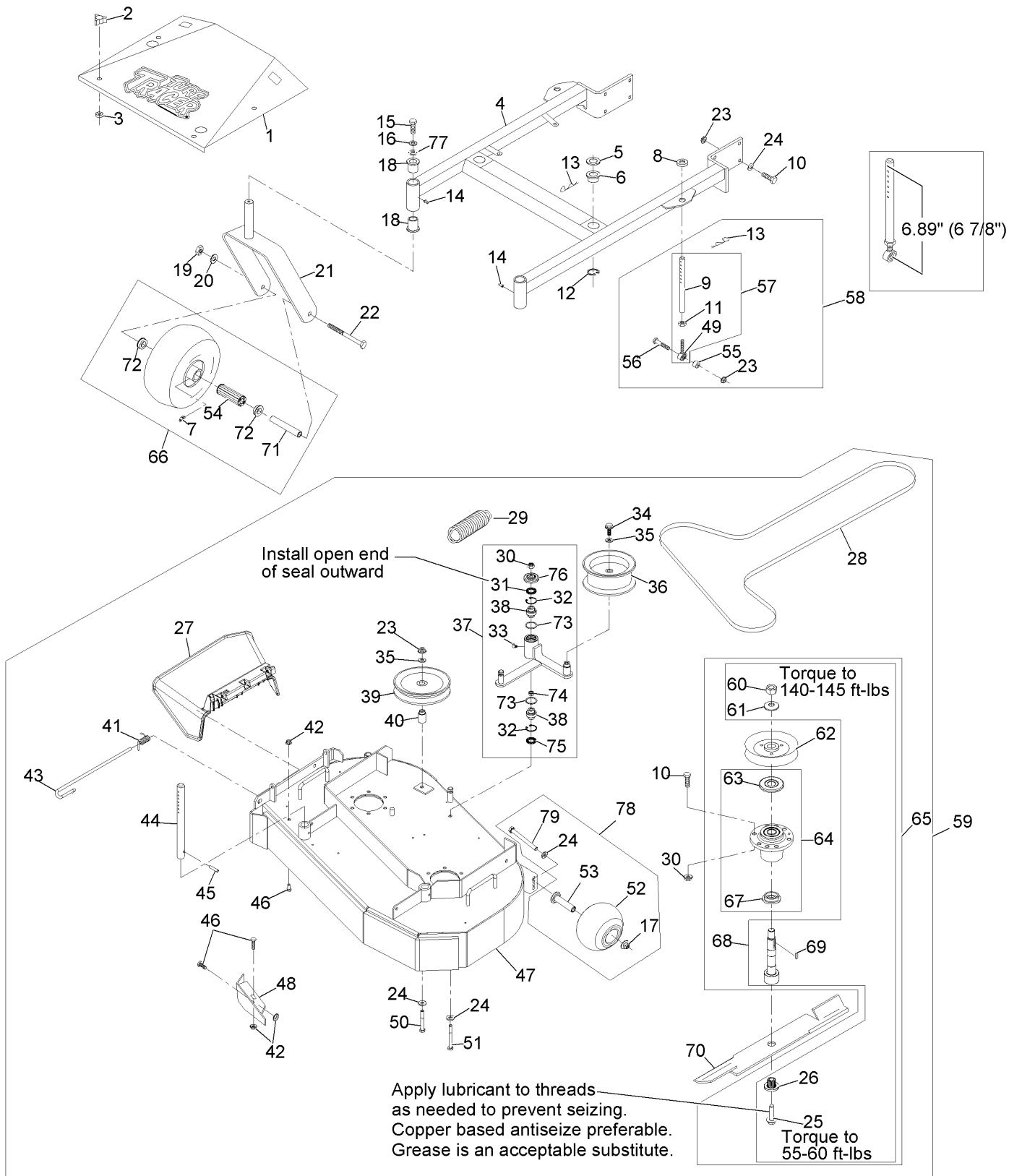

Mower Deck Assembly (continued)

<i>Ref.</i>	<i>Part Number</i>	<i>Qty.</i>	<i>Description</i>	<i>Ref.</i>	<i>Part Number</i>	<i>Qty.</i>	<i>Description</i>
1	116-2710	1	Shield, Belt (1-413098-01) W/Decals	45	1-806332	2	Rollpin 1/4 X 1 1/2
2	1-323385	4	Knob-3 Prong	46	322-2	3	Screw-HH 5/16-18 X 5/8
3	1-323417	4	Washer-Belt Shield	47	1-414383	1	Deck Weldmt W/Decals, Discharge Baffle And Support Rods
4	1-414309	1	Support Wld W/Bushings And Decals	48	116-2297-01	1	Baffle, Discharge
5	1-413425	2	Spacer	49	1-613204	2	Balljoint
6	1-513336	2	Bushing-Deck	50	323-13	1	Screw-HH 3/8-16 X 2 3/4
7	302-61	2	Zerk-45° 1/4-28	51	98-5961	1	Screw-HH 3/8-16 X 4 Gr8
8	1-323539	2	Spacer-Blade Drive	52	103-8415	1	Roller, Anti-Scalp
9	1-413525	2	Link, Rear Deck Support	53	116-8131	1	Axle, Roller
10	323-7	20	Screw-HH 3/8-16 X 1 1/4	54	1-513809	2	Bearing
11	3220-3	2	Nut-Jam 3/8-24	55	1-603050	2	Spacer
12	32120-33	2	Ring-Retaining	56	323-9	2	Screw-HH 3/8-16 X 1 3/4
13	1-806009	4	Hairpin-Cotter #206	57	1-414521	2	Link Assy
14	302-52	2	Zerk-1/8-27 Str	58	1-411532	2	Kit, Support Link W/Pin
15	323-6	2	Screw-HH 3/8-16 X 1	59	103-0320	1	Assembly, Cutting Deck Complete
16	3253-5	2	Washer-Lock 3/8 Heavy	60	3217-46	2	Nut-Hex 3/4-16 Heavy
17	109-6658	2	Nut-Nyloc 3/8-16 Flg	61	103-2802	2	Washer-Spring Disc 3/4
18	1-303514	4	Bearing-Flanged	62	1-413424	2	Sheave, W/Hub 6 5/16" O.D. ▲
19	3217-9	2	Nut-Hex 1/2-13	63	103-1330	2	Guard-Bearing Top ▲
20	3253-7	2	Washer-Lock 1/2	64	103-8280	2	Asm, Cutter Housing W/Bearings
21	1-522143-01	2	Fork, Caster	65	103-9081	2	Asm, Cutter Housing Complete
22	325-20	2	Screw-HH 1/2-13 X 6	66	103-2171	2	Kit, Semi-Pneumatic Wheel Replacement
23	3290-357	10	Nut-Whizlock 3/8-16	67	103-2535	2	Spacer-Guard Bottom
24	98-5975	11	Washer-Spring Disc 3/8	68	103-9071	2	Kit, Spindle ▲
25	109-9220	2	Screw-Sems 1/2-20 X 2.19	69	1-807268	2	Key-Machine 1/4 X 3/16 X 1
26	103-3037	2	Bushing, Splined	70	103-6402	2	Blade-Notched
27	109-5151	1	Deflector-Discharge	70	103-6392	2	Blade, Mulching ■
28	1-413094	1	Belt, Deck Drive	70	103-6387	2	Blade, Low Lift
29	103-3330	1	Spring-Extension	70	103-6382	2	Blade, Solid
30	3296-39	13	Nut-Nyloc 3/8-16	70	116-5175	2	Blade-Extreme 2, 18.00"
31	103-3506	1	Seal-Single Lip	71	1-513547	2	Spacer
32	32120-10	2	Ring-Retaining	72	1-513810	4	Bushing-Flanged
33	302-40	1	Zerk-90° 1/4-28	73	106-7159	2	O-Ring
34	3234-11	1	Screw-HH Flg 3/8-16 X 1	74	103-5677	1	Spacer
35	3256-24	2	Washer-3/8 Sae	75	103-3505	1	Seal-Double Lip
36	116-4666	1	Idler-Pulley, Flat	76	103-2916	1	Guard-Top
37	103-8584	1	Kit, Idler Arm (103-7327-03) W/Brgs ●	77	1-373034	2	Washer
38	103-3504	2	Bearing-Spherical	78	116-9981	1	Kit, Anti-Scalp Roller
39	1-613098	1	Pulley-Idler	79	116-9362	1	Screw-HH 3/8-16 X 3 3/4 Gr 8
40	1-413113	1	Bushing-Idler				
41	116-0962	1	Spring, Torsion				
42	32128-20	3	Nut-Whizlock 5/16-18				
43	109-8854	1	Pin-Chute				
44	1-603001	2	Rod, Deck Support				

● Assembly also includes Washer and Screw

■ Requires installation of mulch kit for proper mulching. See your Exmark dealer for details.

▲ Apply Mobil HTS grease (P/N 103-5217 1.5 oz packet) (or a food-grade anti-seize). See operator s manual for locations.

Engine Deck Assembly

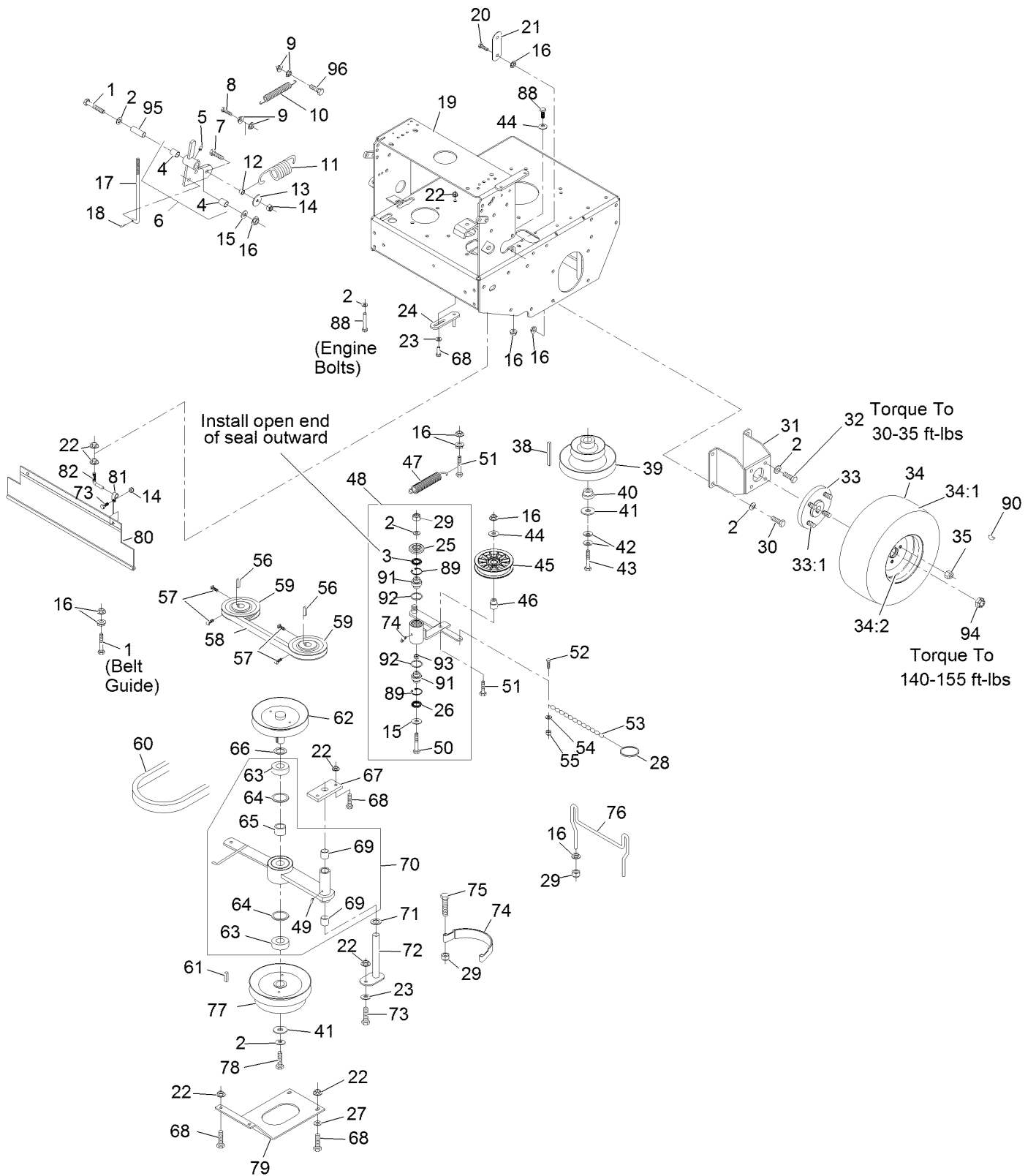

Engine Deck Assembly (continued)

<i>Ref.</i>	<i>Part Number</i>	<i>Qty.</i>	<i>Description</i>	<i>Ref.</i>	<i>Part Number</i>	<i>Qty.</i>	<i>Description</i>
1	323-11	2	Screw-HH 3/8-16 X 2 1/4	46	1-603496	1	Bushing-Idler
2	98-5975	23	Washer-Spring Disc 3/8	47	103-8599	1	Spring, Extension
3	103-3506	1	Seal-Single Lip	48	109-1296	1	Kit, Idler Arm (109-1208-03) W/Brgs
4	1-513034	2	Sleeve-Bearing	49	1481	2	Zerk-45° 1/4-28
5	302-19	1	Zerk-1/4-28 Str	50	98-5961	1	Screw-HH 3/8-16 X 4 Gr8
6	1-414143	1	Link Pivot W/Bearing	51	323-9	2	Screw-HH 3/8-16 X 1 3/4
7	322-6	1	Screw-HH 5/16-18 X 1 1/4	52	1-809069	1	Screw-HSH #10-24 X 7/8
8	321-6	1	Screw-HH 1/4-20 X 1	53	1-323365	1	Chain-Link, Twist
9	32128-33	4	Nut-Whizlock 1/4-20	54	3256-14	1	Washer-#10 Std
10	1-523498	1	Spring, Motion Control	55	3296-2	1	Nut-Nyloc #10-24
11	103-7398	1	Spring, Belt Tension	56	1-807272	2	Key-5Mm X 5Mm X 25Mm
12	1-543007	1	Spacer	57	120-6474	4	Screw-Set, SQH 5/16-18 X 3/4 ■
13	1-213069	1	Washer	58	109-1057	1	Belt, Pump Drive
14	3296-29	3	Nut-Nyloc 5/16-18	59	1-413010	2	Sheave ASM ●
15	3256-4	2	Washer-3/8 Std	60	103-6317	1	Belt, Blade Clutch
16	3290-357	19	Nut-Whizlock 3/8-16	61	1-807259	1	Key-Machine 1/4 X 1/4 X 1
17	1-413282	1	Linkage, Lower	62	103-6308	1	Sheave W/Shaft ●
18	1-806003	1	Hairpin-Cotter	63	1-413111	2	Bearing, Clutch Shaft ●
19	116-6129	1	Asm, Deck (116-6080-01) W/Decals	64	32120-8	2	Ring-Retaining
20	323-4	2	Screw-HH 3/8-16 X 3/4	65	1-413012	1	Spacer, Bearing Clutch
21	1-633068	1	Arm-Lift, Deck	66	1-523157	1	Washer
22	32128-20	11	Nut-Whizlock 5/16-18	67	1-413049-01	1	Plate, Clutch Pivot
23	1-303334	2	Washer-Spring Disc 5/16	68	322-5	7	Screw-HH 5/16-18 X 1
24	1-322110	1	Guide-Belt	69	1-413207	2	Pivot, Bearing
25	103-2916	1	Guard-Top	70	1-414418	1	Clutch Arm W/Bearings
26	103-3505	1	Seal-Double Lip	71	1-413235	1	Washer, Spacer
27	3256-3	2	Washer-5/16 Std	72	1-412138-03	1	Pivot Pin Weldment
28	1-323366	1	Ring-Split	73	322-3	3	Screw-HH 5/16-18 X 3/4
29	3296-39	5	Nut-Nyloc 3/8-16	74	1-413062	1	Band, Brake Clutch
30	323-6	8	Screw-HH 3/8-16 X 1	75	323-8	2	Screw-HH 3/8-16 X 1 1/2
31	1-412080-01	2	Mount, Wheel Motor 36"	76	103-6310	1	Wld, Belt Guide
32	323-6	8	Screw-HH 3/8-16 X 1	77	1-412031	1	Sheave, W/Drum (36") ●
33	112-9049	2	Wheel Hub ASM	78	1-800521	1	Screw-HH 3/8-24 X 1 ■
33:1	1-633926	8	Stud-Wheel	79	1-413009-01	1	Plate, Guard
34	1-413473	2	Wheel And Tire ASM	80	103-2056	1	Shield-Drag
34:1	1-413474	2	Tire-Turfmaster	81	1-413510	2	Clip-Loom
34:2	1-603715	2	Wheel-Rim	82	1-413511	2	Hanger, Drag Shield
35	242-50	8	Nut-Lug 1/2-20	88	323-7	5	Screw-HH 3/8-16 X 1 1/4
38	1-807264	1	Key-Machine 1/4 X 1/4 X 2 5/8	89	32120-10	2	Ring-Retaining
39	103-6309	1	Asm, Drive Sheave ●	90	1-807019	2	Key-Woodruff 1 X 1/4
40	1-603609	1	Bushing, Clutch Keeper	91	103-3504	2	Bearing-Spherical
41	1-373034	2	Washer	92	106-7159	2	O-Ring
42	1-603610	2	Washer-Spring Disc 7/16	93	103-5677	1	Spacer
43	3212-10	1	Screw-HH 7/16-20 X 2 1/2 ■	94	116-2839	2	Nut-Lock
44	3256-24	2	Washer-3/8 Sae	95	1-603044	1	Bushing
45	109-4077	1	Pulley-Idler, Flat	96	321-8	1	Screw-HH 1/4-20 X 1 1/4

● Apply anti-seize compound in bore.

■ Use Pro-Lock, Nut Type (P/N 1-840022, .5ml tube) on threads.

Engine Deck Assembly (cont)

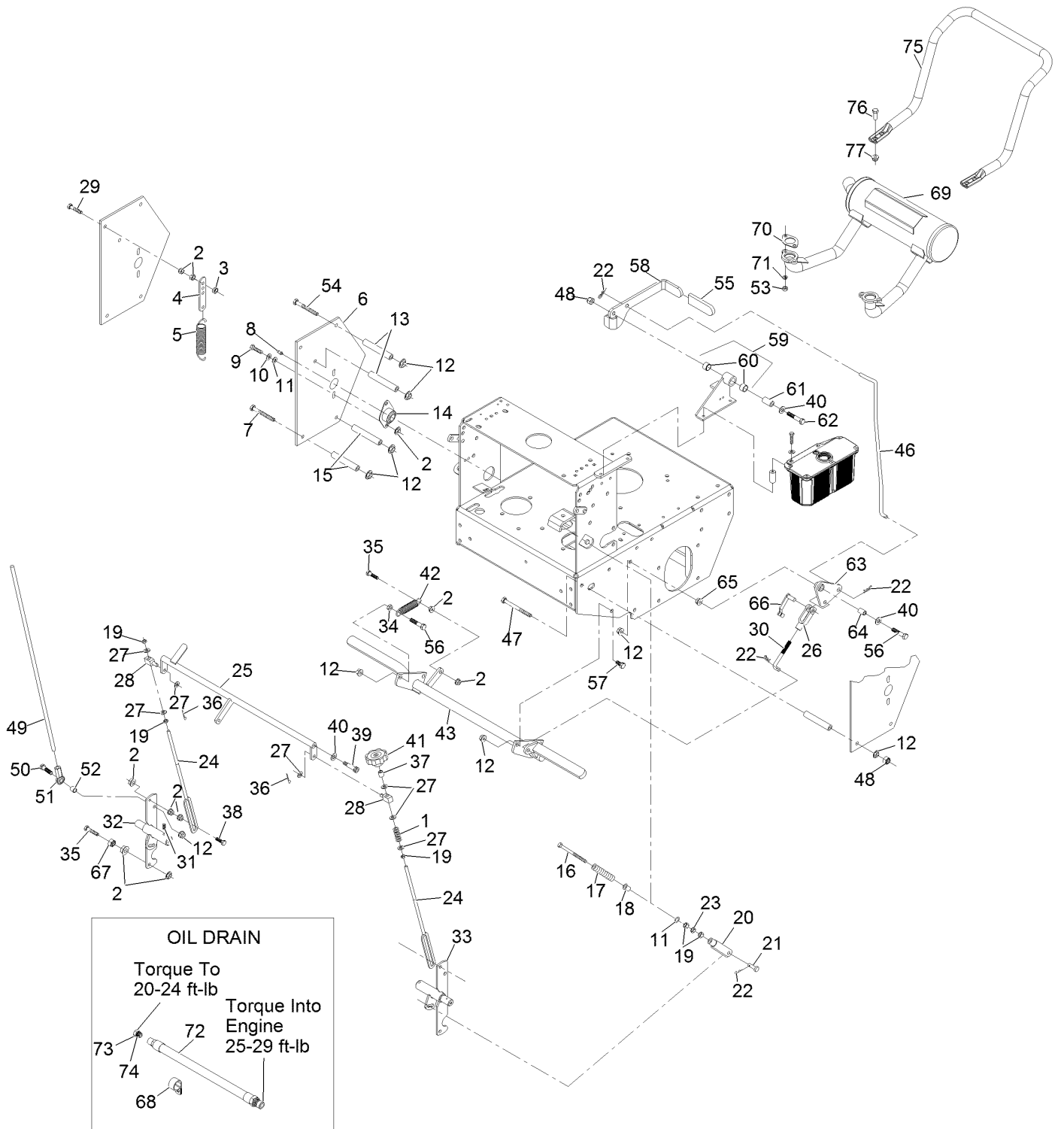

Engine Deck Assembly (cont) (continued)

<i>Ref.</i>	<i>Part Number</i>	<i>Qty.</i>	<i>Description</i>	<i>Ref.</i>	<i>Part Number</i>	<i>Qty.</i>	<i>Description</i>
1	1-323245	1	Spring-Compression	40	3256-24	4	Washer-3/8 Sae
2	32128-20	20	Nut-Whizlock 5/16-18	41	103-3060	1	Knob-Tracking
3	3296-29	2	Nut-Nyloc 5/16-18	42	1-323161	1	Spring
4	1-613089	2	Tab-Spring, Extension	43	103-2085-03	1	Brake ASM
5	1-603693	2	Spring	46	1-413492	1	Linkage, Upper Brake
6	110-4897-01	2	Shield-Control	47	323-23	1	Screw-HH 3/8-16 X 4-1/2
7	323-16	6	Screw-HH 3/8-16 X 4	48	3296-39	2	Nut-Nyloc 3/8-16
8	302-19	2	Zerk-1/4-28 Str	49	103-1148	2	Rod, Drive Lever
9	322-3	4	Screw-HH 5/16-18 X 3/4	50	323-8	2	Screw-HH 3/8-16 X 1 1/2
10	1-805005	4	Washer-Lock 5/16 Heavy	51	103-1167	2	Joint-Ball End, .38X.38Fe LH
11	3256-2	6	Washer-1/4 Std	52	103-1166	2	Spacer-Tube, Pump Link
12	3290-357	15	Nut-Whizlock 3/8-16	53	114-3549	4	Nut-M8
13	1-323195-01	4	Spacer-Shield	54	323-16	1	Screw-HH 3/8-16 X 4
14	1-633102	2	Bearing-Flanged	55	1-303020	1	Grip-Lever
15	1-323197-01	4	Spacer-Shield	56	323-9	2	Screw-HH 3/8-16 X 1 3/4
16	1-603737	2	Bolt-Neutral Return	57	323-4	3	Screw-HH 3/8-16 X 3/4
17	103-0265	2	Spring, Neutral Return	58	103-3495	1	Lever, Park Brake (116-1725-03) W/Decals
18	1-603735	2	Bushing-Flanged	59	1-414504	1	Bracket ASM
19	3219-2	7	Nut-Hex 5/16-24	60	1-413347	2	Sleeve-Bushing
20	1-303105	2	Yoke-Adjustable	61	1-413344	1	Bushing-Pivot
21	1-808280	2	Pin-Clevis 5/16 X 1 49/64	62	323-10	1	Screw-HH 3/8-16 X 2
22	1-806003	5	Hairpin-Cotter	63	1-414508	1	Bellcrank ASM
23	3220-2	2	Nut-Jam 5/16-24	64	1-303548	1	Bushing-Plastic
24	1-413350	2	Link-Control, Speed	65	32128-21	1	Nut-3/8-16 Flanged Side Lock
25	1-412203-01	1	Crank-Control, Speed	66	103-2399	1	Pin-Clevis Spring 3/8
26	1-633131	1	Yoke-Linkage, Brake	67	3218-2	2	Nut-Jam 5/16-18
27	3256-23	7	Washer-5/16 Sae	68	1-643312	1	Clip-Loom
28	1-603676	2	Swivel-Adjustable, Short	69	116-3735	1	Muffler-Horizontal
29	1-800016	2	Bolt-HH 5/16-18 X 1 1/4 Tap	70	1-653313	2	Gasket-Exhaust
30	1-413489	1	Linkage-Lower	71	114-3550	4	Washer-Lock, Spring
31	1-803022	2	Setscrew-5/16-18 X 5/8 ■	72	116-5052	1	Asm-Oil Drain Hose W/Plug ●
32	103-1190-01	1	Shaft-Control, LH	73	353-508	1	Plug-W/O-Ring
33	103-4796-01	1	Shaft-Control, RH	74	237-42	1	O-Ring
34	3218-3	1	Nut-Jam 3/8-16	75	116-6278-03	1	Guard-Muffler
35	116-3515	3	Screw, HH Special 5/16-18 X 1.25	76	323-6	4	Screw-HH 3/8-16 X 1
36	3272-5	2	Pin-Cotter 3/32 X 1/2	77	104-8301	4	Nut-Nyloc 3/8-16 Flg
37	1-603903	1	Spacer				
38	1-403180	2	Screw-HH 5/16-18 X 1 3/8 Special				
39	1-809056	2	Screw-Sh 5/16-18 X 1 3/8 ■				

● Use a Teflon Pipe Sealant or equivalent on threads.

■ Use Pro-Lock, Nut Type (P/N 1-840022, .5ml tube) on threads.

ECS Upper Handles and Controls Assembly

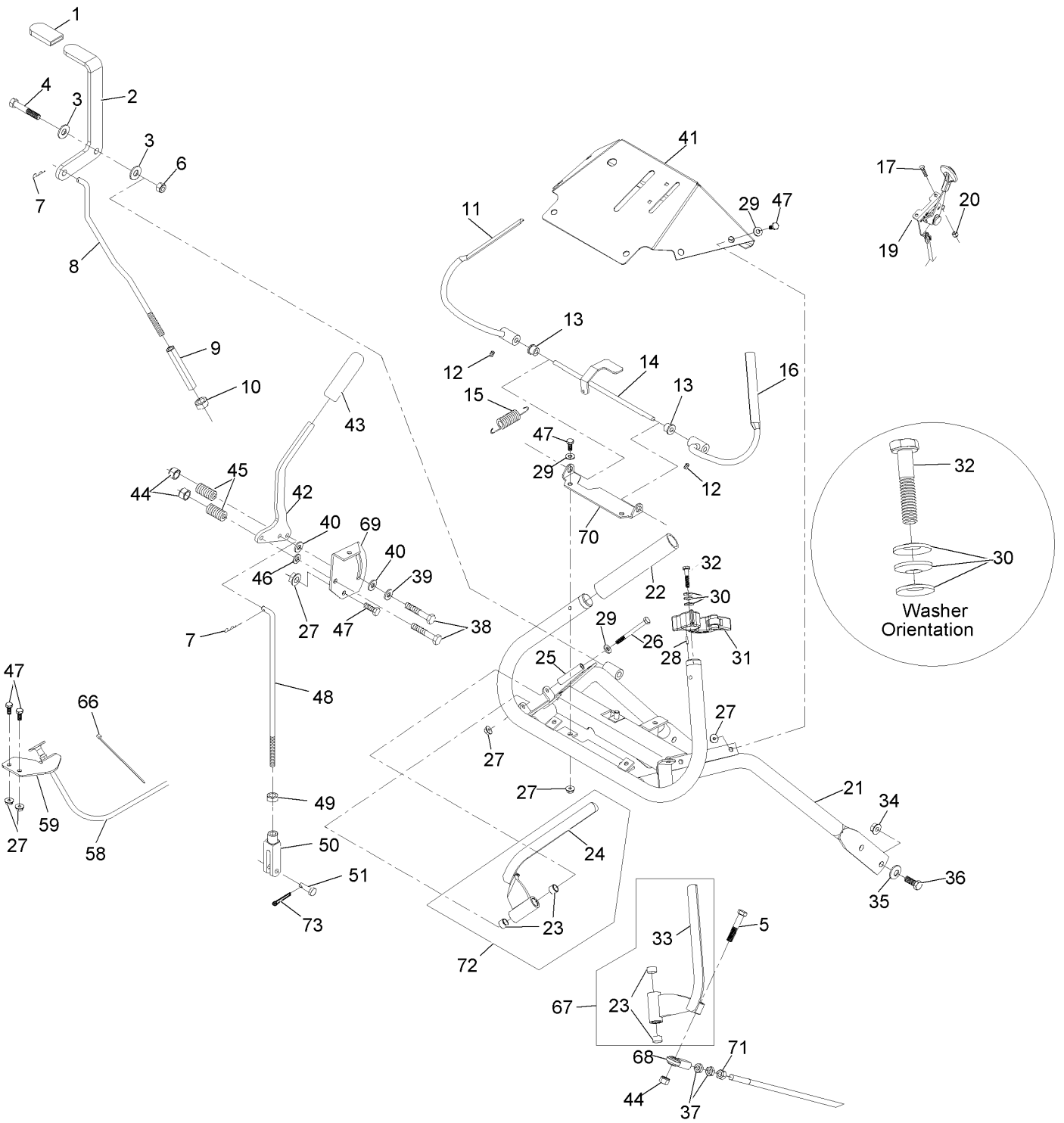

ECS Upper Handles and Controls Assembly (continued)

Ref.	Part Number	Qty.	Description	Ref.	Part Number	Qty.	Description
1	1-303020	1	Grip-Lever	32	103-0235	2	Screw-HH 1/4-20 X 1 1/8 W/Nylon ●
2	116-6334	1	Asm, Lever (116-1736-03) W/Grip	33	116-4082-03	1	Lever, Drive RH
3	3256-4	2	Washer-3/8 Std	34	3290-357	4	Nut-Whizlock 3/8-16
4	323-11	1	Screw-HH 3/8-16 X 2 1/4	35	98-5975	4	Washer-Spring Disc 3/8
5	322-9	2	Screw-HH 5/16-18 X 1 3/4	36	323-6	4	Screw-HH 3/8-16 X 1
6	3296-39	1	Nut-Nyloc 3/8-16	37	3220-3	4	Nut-Jam 3/8-24
7	1-806003	2	Hairpin-Cotter	38	322-10	4	Screw-HH 5/16-18 X 2
8	103-1149	1	Linkage, Upper	39	1-603716	1	Washer-Friction Disc
9	1-413279	1	Turnbuckle, 3/8-16 Ss	40	1-323244	2	Washer-Friction
10	3217-7	1	Nut-Hex 3/8-16	41	109-4651	1	Asm, Console (109-4649-03)W/ Decals
11	116-4079	1	Wld, Lever, Opc (LH) ■	42	116-8632	1	Lever-Shift W/Grip
12	1-803322	2	Setscrew-5/16-24 X 5/16 ●	43	103-5994	1	Grip, Steering Handle
13	1-303365	2	Bushing-Nylon	44	3296-29	4	Nut-Nyloc 5/16-18
14	103-0769-03	1	Rod Weldment, Opc	45	1-323245	2	Spring-Compression
15	1-303363	1	Spring-Extension	46	3256-23	1	Washer-5/16 Sae
16	116-4080	1	Wld, Opc Lever (RH) ■	47	321-3	12	Screw-HH 1/4-20 X 5/8
17	1-807513	2	Bolt-Carriage #10-24 X 1/2	48	1-413225	1	Rod, Speed Control
19	116-2426	1	Cable, Throttle	49	3220-2	1	Nut-Jam 5/16-24
20	3296-2	2	Nut-Nyloc #10-24	50	1-303105	1	Yoke-Adjustable
21	103-0770-03	1	Handle Weldment (1-412449)	51	1-808280	1	Pin-Clevis 5/16 X 1 49/64
22	103-0815	2	Grip-Bar, Handle	58	103-1796	1	Cable-Choke
23	1-413152	4	Bushing-Sleeve	59	103-1797-01	1	Bracket-Cable, Choke
24	116-4081-03	1	Lever, Drive LH	66	1-303287	1	Tie-Cable 5 1/2 (Small)
25	103-0027	2	Bushing-Lever, Drive	67	103-2513	1	Asm, Drive Lever RH
26	321-14	2	Screw-HH 1/4-20 X 2 3/4	68	103-2463	2	Balljoint
27	32128-33	14	Nut-Whizlock 1/4-20	69	103-0503	1	Bracket, Shifter Slide
28	103-0464	2	Pin-Spring 1/8 X 1/2	70	103-0489-03	1	Bracket, Opc Axle
29	3256-22	10	Washer-1/4 Sae	71	3219-3	2	Nut-Hex 3/8-24
30	1-303435	6	Washer-Spring Disc 1/4	72	103-2514	1	Asm, Drive Lever LH
31	103-1371	1	Thumb Latch Asm RH	73	3272-5	1	Pin-Cotter 3/32 X 1/2
31	103-1372	1	Thumb Latch Asm LH				

● Use Pro-Lock, Nut Type (P/N 1-840022, .5ml tube) on threads.

■ Use Pro-Lock retaining type, Part no. 1-840023 (.5cc tube) on inside of bore of OPC hub.

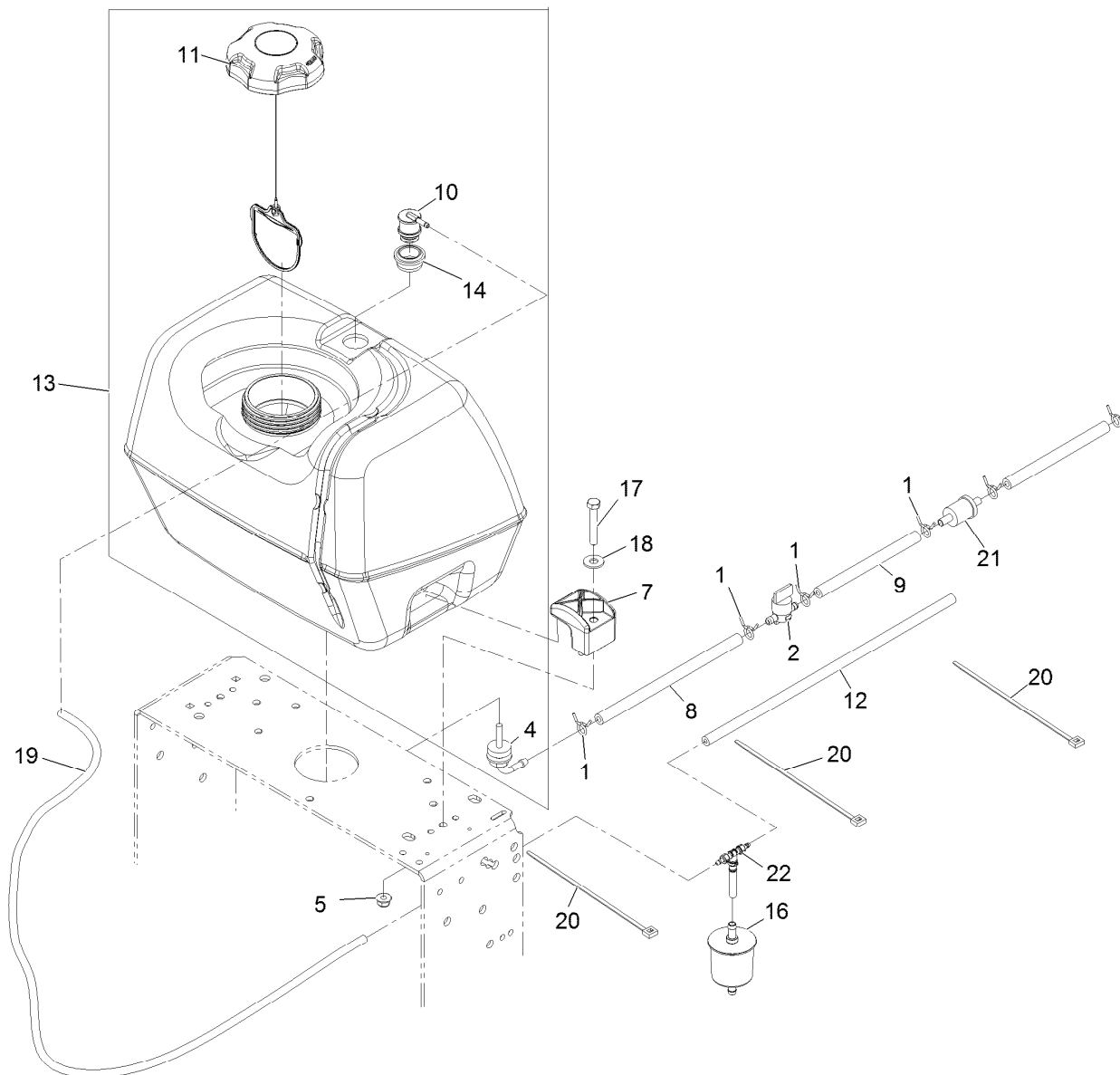

Fuel Tank Assembly

Ref.	Part Number	Qty.	Description
1	2412-98	4	Clamp-Hose
2	1-603770	1	Valve-Fuel
4	103-2605	1	Fitting-Fuel Bulkhead W/Strainer ▲
5	104-8300	2	Nut-Nyloc 5/16-18 Fig
7	107-4543	2	Clamp
8	109-0650	1	Hose-Fuel
9	99-9415	1	Hose-Fuel
10	114-0285	1	Valve-Rollover
11	115-4465	1	Cap-Fuel, Ratcheting
12	115-7872	1	Hose-Fuel

Ref.	Part Number	Qty.	Description
13	116-3656	1	ASM, Fuel Tank
14	119-6549	1	Grommet-Valve, Roll-Over
16	120-2235	1	Filter-Fuel
17	322-10	2	Screw-HH 5/16-18 X 2
18	3256-3	2	Washer-5/16 Std
19	116-4346	1	Hose-Emissions
20	1-303335	3	Tie-Cable 7 15/16 (Large)
21		1	Pn 49019-0014 Filter W/6In Fuel Line ■●
22	116-5464	1	Tee And Check

● Not serviced separately

▲ Use Pro-Lock, Nut Type (P/N 1-840022, .5ml tube) on threads.

■ Obtain parts from www.kawpowerpc.com

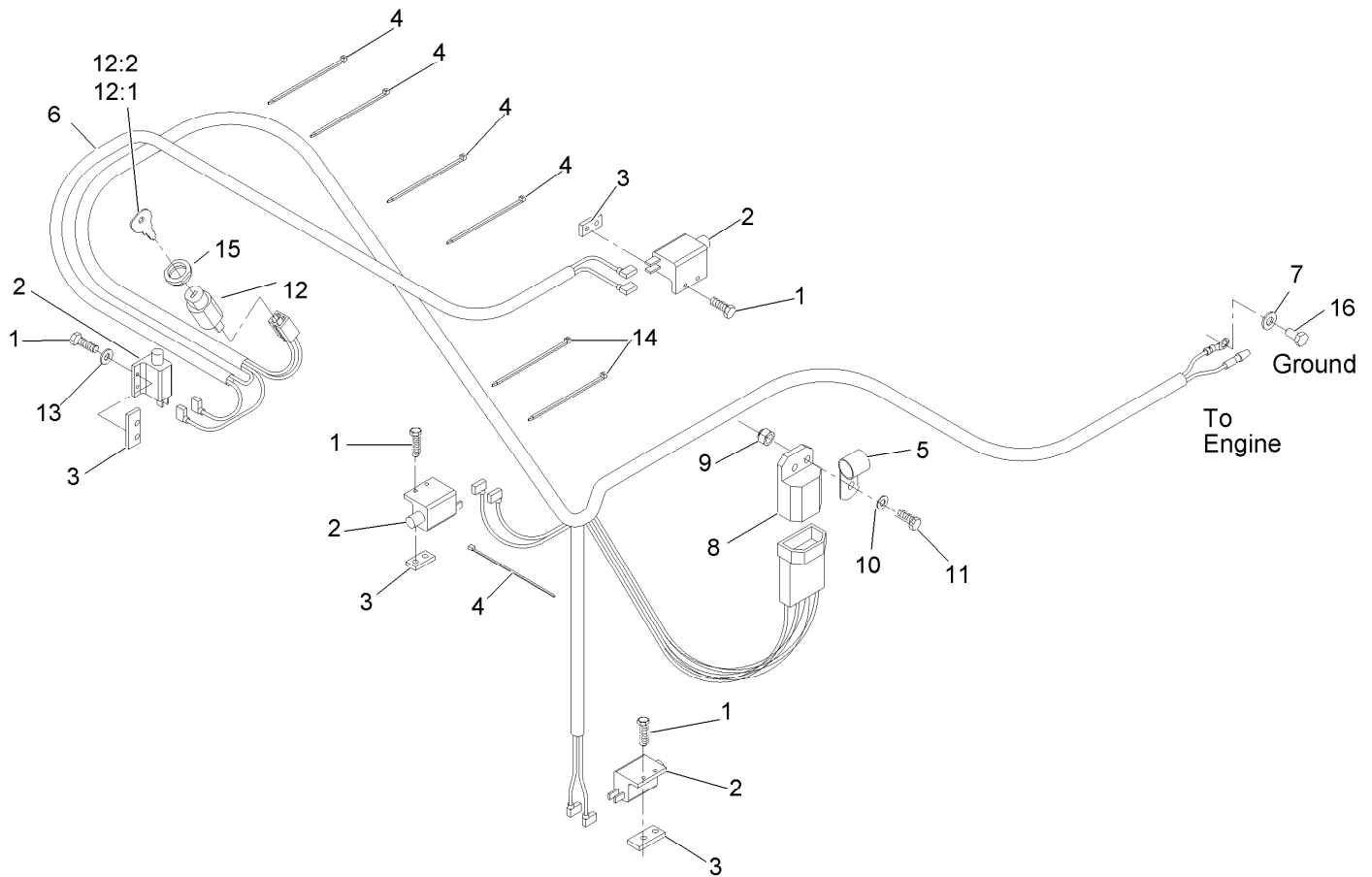

Electrical Assembly

Ref.	Part Number	Qty.	Description	Ref.	Part Number	Qty.	Description
1	3290-500	8	Screw-PPH #10-24 X 5/8	10	3256-22	1	Washer-1/4 Sae
2	1-513051	4	Switch-N.O.	11	321-4	1	Screw-HH 1/4-20 X 3/4
3	1-633181	4	Plate-Tapped	12	1-403121	1	Switch-Key
4	1-303287	5	Tie-Cable 5 1/2 (Small)	12:1	1-603511	1	Key-Ignition
5	1-323229	1	Clip-Loom 3/8	12:2	103-2106	1	Key-Exmark Logo
6	116-2610	1	Harness, Wiring	13	3256-14	1	Washer-#10 Std
7	33094-00	1	Washer	14	1-303335	2	Tie-Cable 7 15/16 (Large)
8	1-323430	1	Module-Interlock	15	103-0498	1	Nut-Ignition
9	3296-42	1	Nut-Nyloc 1/4-20	16	33114-016	1	Screw-HH M8-1.25 X 16Mm

Decals

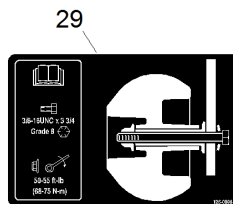
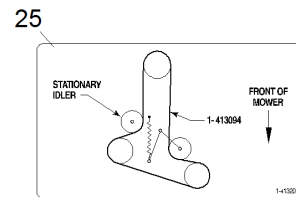
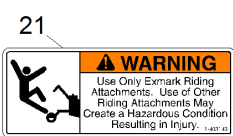
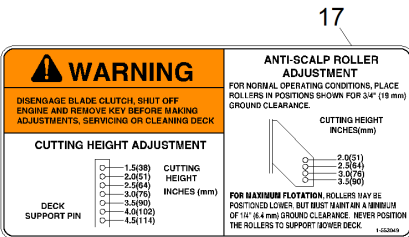
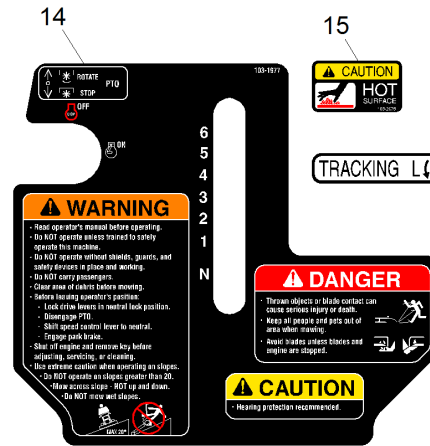
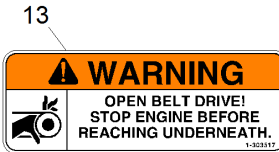
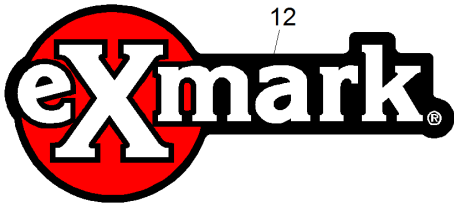
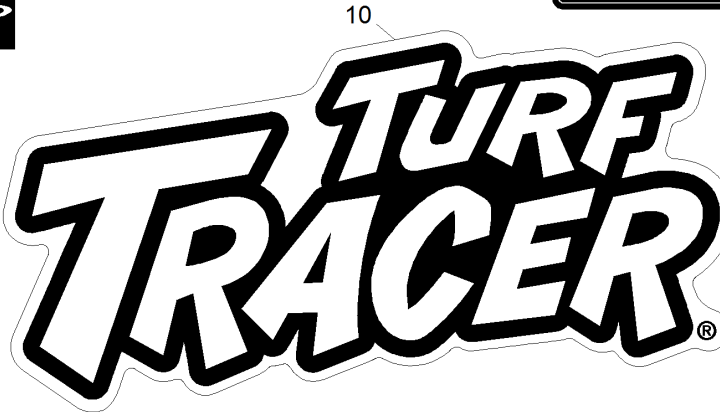
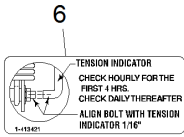
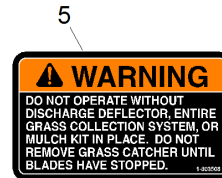
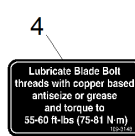
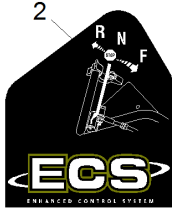
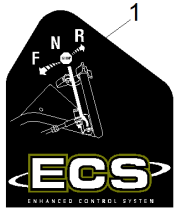

Decals (continued)

<i>Ref.</i>	<i>Part Number</i>	<i>Qty.</i>	<i>Description</i>	<i>Ref.</i>	<i>Part Number</i>	<i>Qty.</i>	<i>Description</i>
1	103-2242	1	Decal, Ecs Instruction LH	15	103-2076	2	Decal-Caution
2	103-2243	1	Decal, Ecs Instruction RH	16	1-413214	1	Decal, Tracking
3	116-4769	1	Decal-Filter, Emissions	17	1-553049	1	Decal, Mower Deck
4	109-3148	1	Decal, Bolt Torque	18	116-4695	1	Decal-Ultracut 36 Series 3
5	1-303508	1	Decal-Warning, Discharge	21	1-403143	1	Decal, Sulky Warning
6	1-413421	1	Decal, Indicator	22	117-2718	1	Decal-Arrester, Spark
7	103-2103	1	Decal-Brake, Park	23	103-4935	1	Decal, Drive Wheel Release
9	116-0404	1	Decal-Hydraulic Tank	24	98-5954	1	Decal-Cover, Missing
10	103-3013	1	Decal, Turf Tracer	25	1-413206	1	Decal, Belt Routing (36")
11	103-1798	1	Decal, Throttle	27	1-403005	2	Decal-Danger
12	103-2882	1	Decal, Exmark Logo	28	116-3884	2	Decal-S-Series
13	1-303517	1	Decal,Belt Drive	29	126-0898	1	Decal-Roller Mounting
14	103-1977	1	Decal, Ecs Console	99	103-2461	1	Decal Kit(Standard) ●

● Not illustrated

Hydraulic Assembly

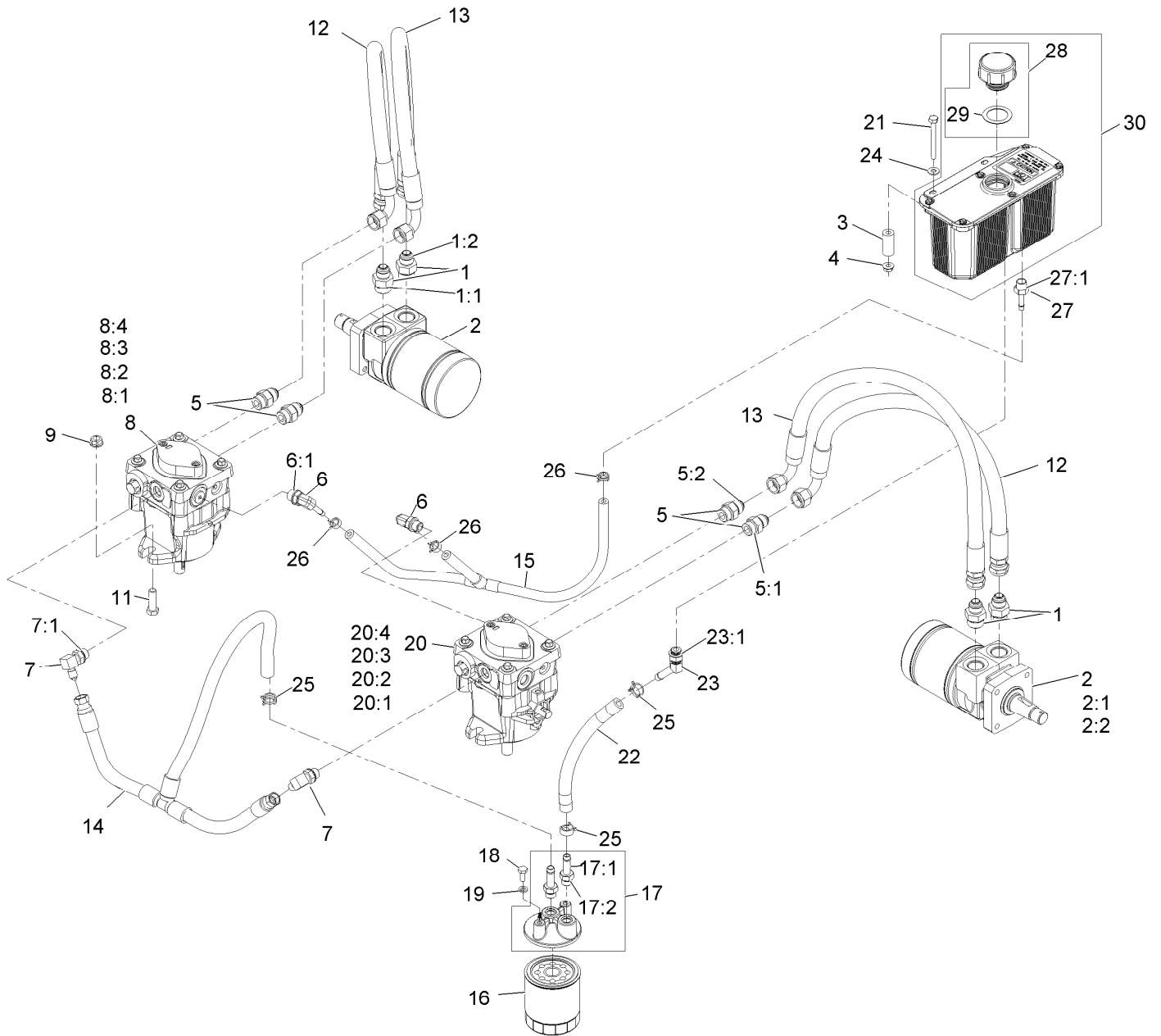

Hydraulic Assembly (continued)

<i>Ref.</i>	<i>Part Number</i>	<i>Qty.</i>	<i>Description</i>	<i>Ref.</i>	<i>Part Number</i>	<i>Qty.</i>	<i>Description</i>
1	1-603991	4	Adapter-Straight	15	116-0918	1	Case Drain Hose ASM
1:1	1-603919	1	O-Ring-Sae #10	16	109-4180	1	Element, Oil Filter
1:2	1-603992	1	O-Ring-37 Flare #8	16	1-523541	1	Element, Oil Filter (Winter) ●
2	1-603718	2	HYD Motor ASM	17	103-2889	1	Filter Head ASM
2:1	1-000138	1	Bearing And Seal Kit	17:1	103-1912	2	Adapter-Straight
2:2	1-000119	1	Seal Kit	17:2	1-603921	1	O-Ring-Sae #6
3	103-2191	2	Spacer	18	321-3	2	Screw-HH 1/4-20 X 5/8
4	32128-33	2	Nut-Whizlock 1/4-20	19	1-805004	2	Washer-Lock 1/4 Heavy
5	1-603990	4	Adapter-Straight	20	116-0943	1	RH HYD Pump ASM
5:1	1-603920	1	O-Ring-Sae #8	20:1	103-2664	1	Input Shaft Kit
5:2	1-603992	1	O-Ring-37 Flare #8	20:2	94-6922	1	Bearing-Thrust
6	103-1799	2	Elbow-90 DEG	20:3	103-2666	1	Cylinder Block Kit
6:1	1-603921	1	O-Ring-Sae #6	20:4	105-6184	1	Seal Overhaul Kit
7	103-1802	2	Fitting-HYD, 90 DEG	21	321-15	2	Screw-HH
7:1	1-603921	1	O-Ring-Sae #6	22	103-2959	1	Hose-Charge
8	116-0942	1	LH HYD Pump ASM	23	103-1807	1	Fitting-Barbed, 45 DEG
8:1	103-2664	1	Input Shaft Kit	23:1	1-603921	1	O-Ring-Sae #6
8:2	94-6922	1	Bearing-Thrust	24	3256-22	2	Washer-1/4 Sae
8:3	103-2666	1	Cylinder Block Kit	25	103-1988	3	Clamp-Hose 11/16
8:4	105-6184	1	Seal Overhaul Kit	26	103-1716	3	Clamp-Hose 17/32
9	32128-43	4	Nut-Whizlock 3/8-16	27	103-1801	1	Adapter-Straight
11	323-7	4	Screw-HH 3/8-16 X 1 1/4	27:1	1-603921	1	O-Ring-Sae #6
12	119-7827	2	HYD Hose ASM	28	103-7615	1	Asm, Cap W/Gasket
13	119-7826	2	HYD Hose ASM	29	103-1949	1	Gasket-Cap
14	116-2123	1	Charge Hose ASM	30	103-1947	1	HYD Reservoir ASM

● Use only for operation below 32°F (0°C).

Notes:

EXMARK® MAINTENANCE

MAXIMIZE THE PERFORMANCE OF YOUR EXMARK.

4-CYCLE PREMIUM ENGINE OIL

Part No. 116-3373

Both SAE 30 and SAE 10W-30 in one bottle.

Contains increased levels of zinc and phosphorus for better lubricity.

No Viscosity Index Improvers that tend to shear down in high heat.

Synthetic formulation.

Gas & Diesel compatible.

Anti-corrosion additives.

API 'SL' and JASO rated with wet clutch compatibility for other machines.

PREMIUM HYDRO OIL

Part No. 109-9828

Commercial quality for tough, high-heat conditions.

Designed specifically for zero-turn mower hydraulic systems.

Superior shear resistance under heavy loads.

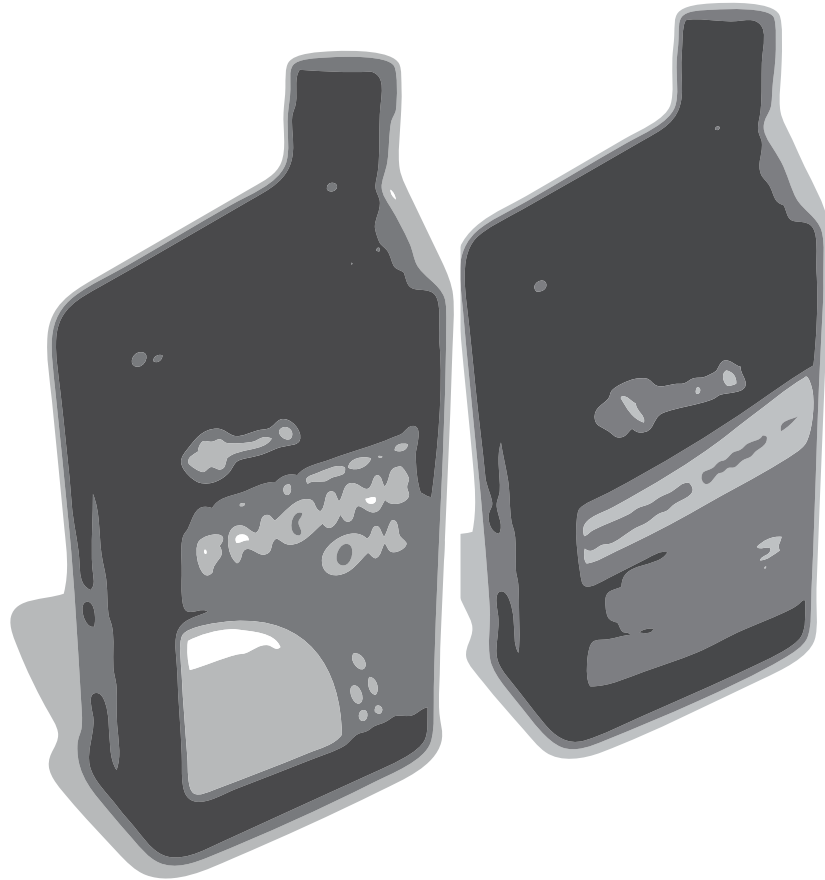

Available from your local Exmark dealer. Find your closest dealer at exmark.com

EXMARK ACCESSORIES AND OPTIONS*

MID-MOUNT RIDING ACCESSORIES AND OPTIONS

CUSTOM RIDE SEAT SUSPENSION SYSTEM	OPERATOR CONTROLLED DISCHARGE
FULL SUSPENSION SEAT	SUN SHADE
DECK LIFT ASSIST KIT	TRASH CONTAINER
HITCH KIT	TURF STRIPER
LIGHT KIT	ULTRA VAC COLLECTION SYSTEM
12V POWER PORT	ULTRA VAC QUICK DISPOSAL SYSTEM
MICRO-MULCH SYSTEM	

OUT-FRONT RIDING ACCESSORIES AND OPTIONS

CUSTOM RIDE SEAT SUSPENSION SYSTEM	SNOW BLADE
DUAL-TAIL WHEEL	SNOWBLOWER
FLOOR PAN EXTENDER	SUN SHADE
HITCH KIT	TRASH CONTAINER
LIGHT KIT	ULTRA VAC COLLECTION SYSTEM
MICRO-MULCH SYSTEM	ULTRA VAC QUICK DISPOSAL SYSTEM
ROLL OVER PROTECTION SYSTEM (ROPS)	WEATHER CAB

WALK-BEHIND ACCESSORIES AND OPTIONS

GRASS CATCHER	TURF STRIPER
MICRO-MULCH SYSTEM	STANDON

*Some accessories and options not available for some models.

Place Model No. and Serial No.
Label Here (Included in the Literature
Pack) or Fill in Below

Model No. _____

Serial No. _____

Date Purchased _____

Engine Model No. and Spec. No. _____

Engine Serial No. (E/No) _____

© 2014 Exmark Mfg. Co., Inc.
Industrial Park Box 808
Beatrice, NE 68310
All Rights Reserved

Part No. 4501-820 Rev. A
(402) 223-6300
Fax (402) 223-5489
Printed in the USA.

